

# Triangle Contact Systems for Planar Graphs.

Daniel Gonçalves  
LIRMM, Montpellier

BGW 2010

Theorem (de Fraysseix, Ossona de Mendez, Rosenstiehl '94)

Every planar graph admits a contact representation by triangles.

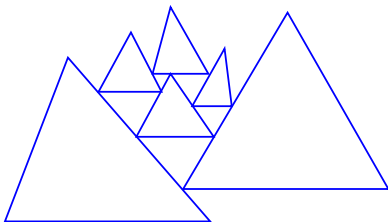

Theorem (de Fraysseix, Ossona de Mendez, Rosenstiehl '94)

Every planar graph admits a contact representation by triangles.

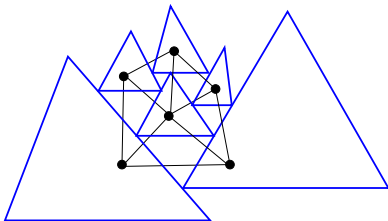

# Shelling Order in Triangulations

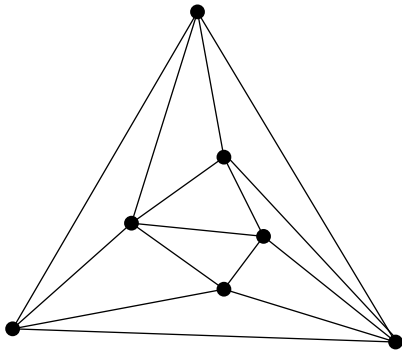

# Shelling Order in Triangulations

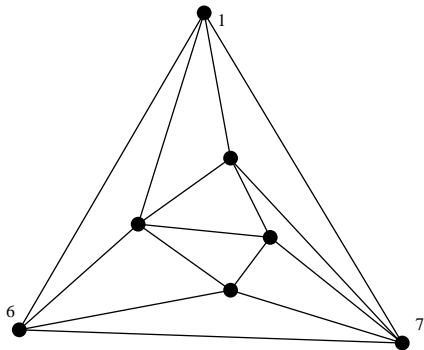

# Shelling Order in Triangulations

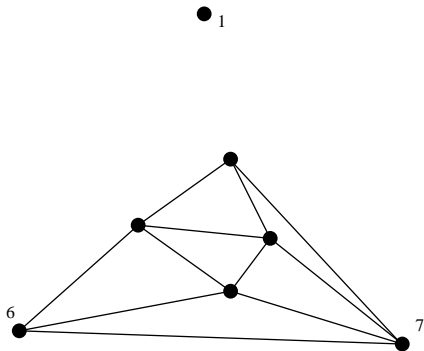

# Shelling Order in Triangulations

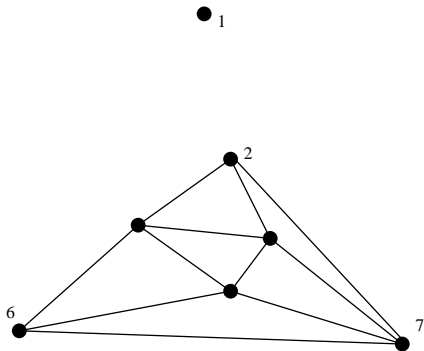

# Shelling Order in Triangulations

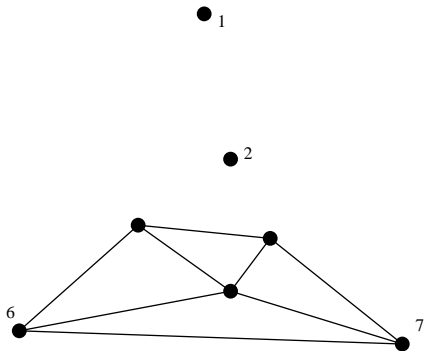



# Shelling Order in Triangulations

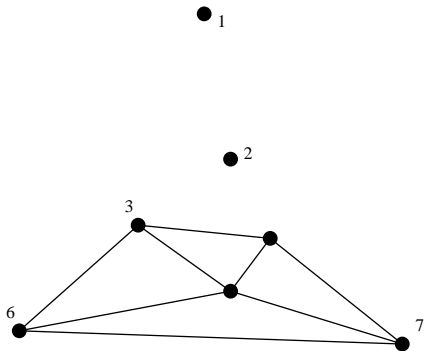

# Shelling Order in Triangulations

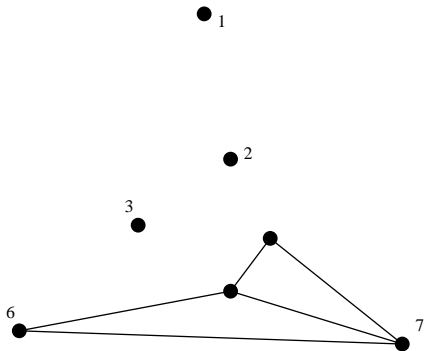

# Shelling Order in Triangulations

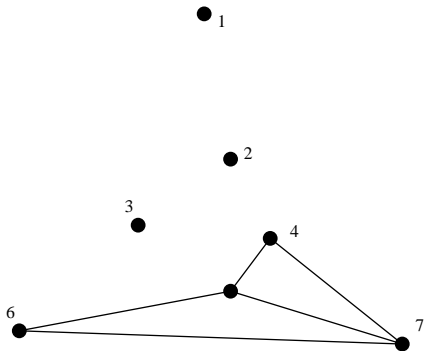

# Shelling Order in Triangulations

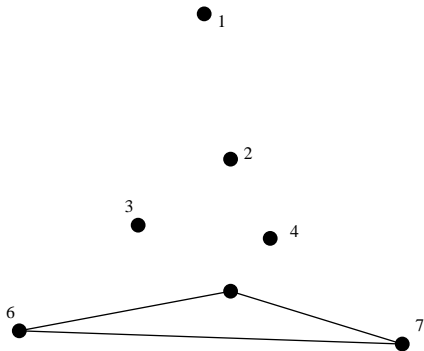

# Shelling Order in Triangulations

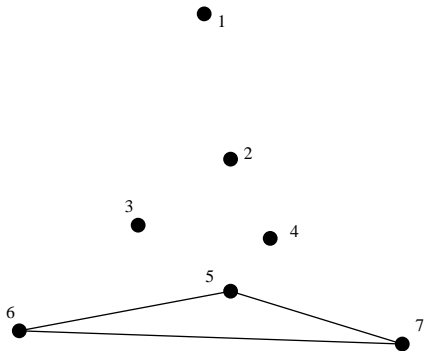

# Shelling Order in Triangulations

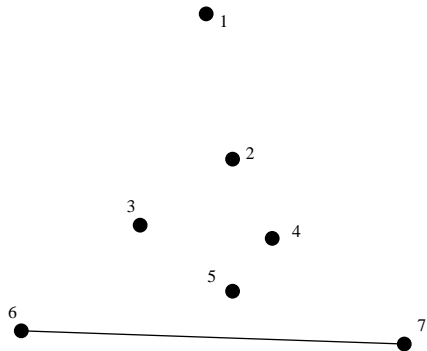

# Shelling Order in Triangulations

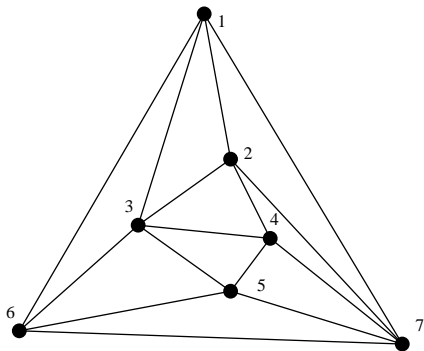

# Shelling Order in Triangulations

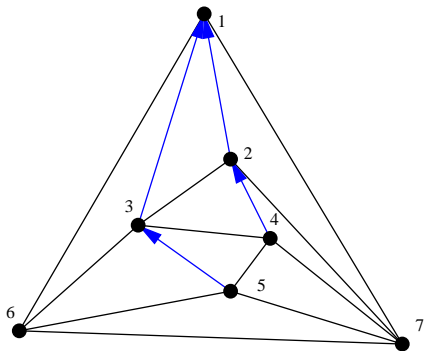



# Proof : Construction

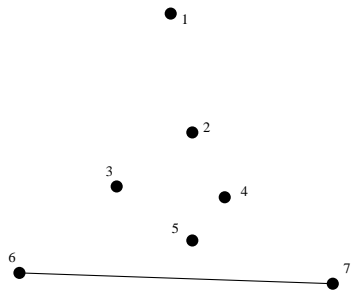

# Proof : Construction

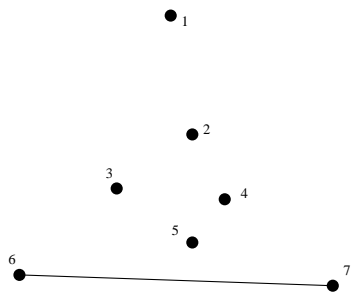

0 \_

1 \_

2 \_

3 \_

4 \_

5 \_

6 \_

7 \_

# Proof : Construction

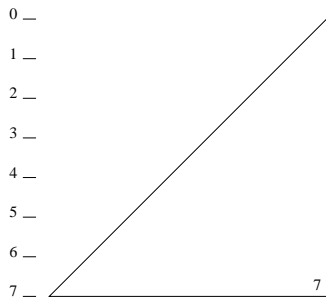
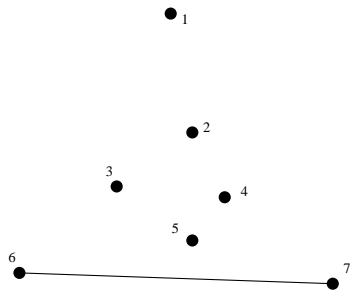

# Proof : Construction

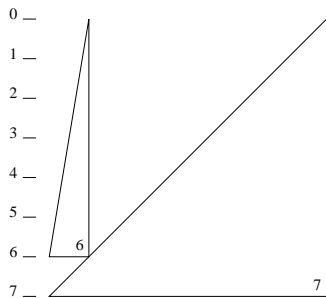
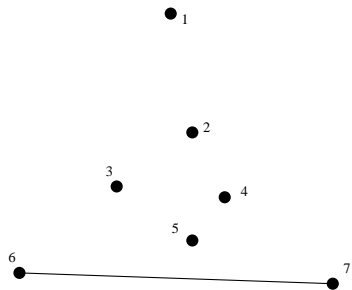

# Proof : Construction

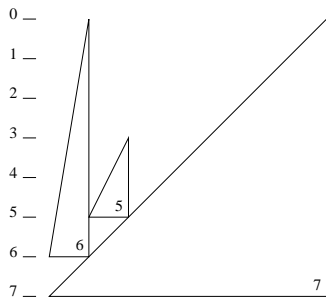
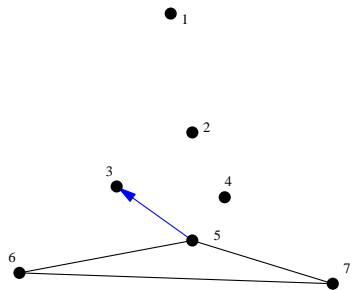

# Proof : Construction

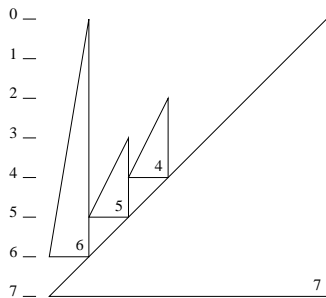
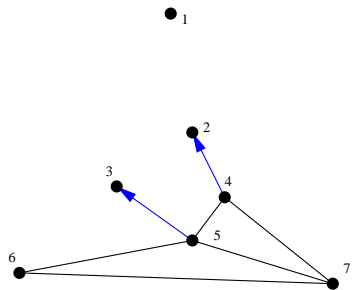

# Proof : Construction

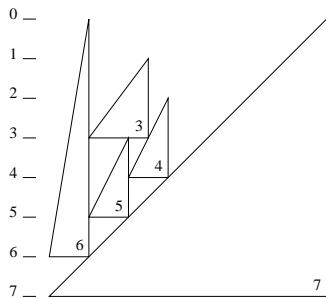
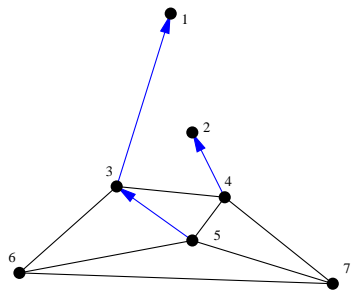

# Proof : Construction

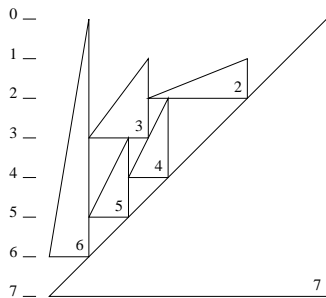
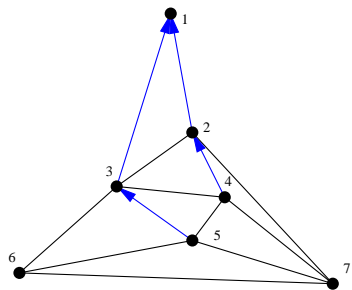



# Proof : Construction

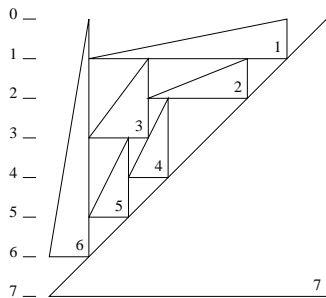
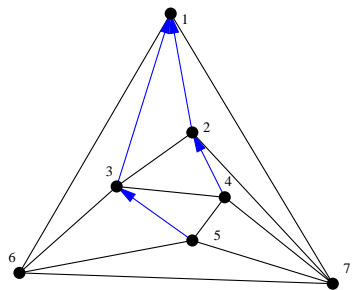

# Correspondence with Schnyder woods

## Definition

A Schnyder wood of a triangulation  $T$  is an orientation of  $E(T)$  and a 3-edge coloring of  $T$  such that every inner vertex verifies :

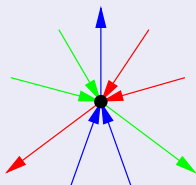

## Correspondence with Schnyder woods

Theorem (de Fraysseix, Ossona de Mendez, Rosenstiehl '94)

Contact representations by triangles of a planar triangulation are in one-to-one correspondence with its Schnyder wood.

# Correspondence with Schnyder woods

Theorem (de Fraysseix, Ossona de Mendez, Rosenstiehl '94)

Contact representations by triangles of a planar triangulation are in one-to-one correspondence with its Schnyder wood.

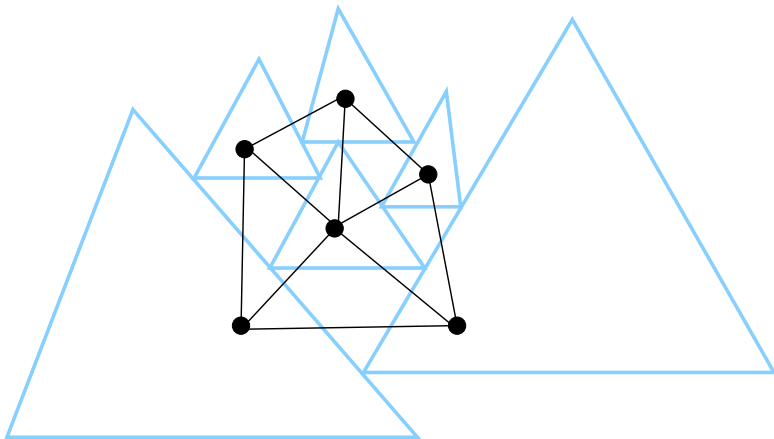

# Correspondence with Schnyder woods

Theorem (de Fraysseix, Ossona de Mendez, Rosenstiehl '94)

Contact representations by triangles of a planar triangulation are in one-to-one correspondence with its Schnyder wood.

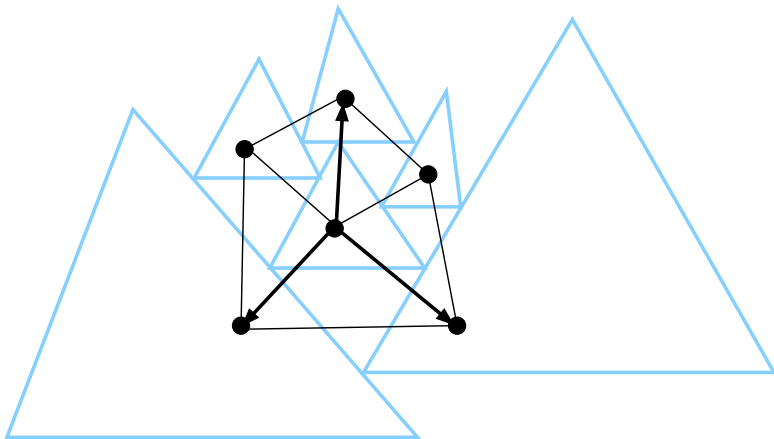

# Correspondence with Schnyder woods

Theorem (de Fraysseix, Ossona de Mendez, Rosenstiehl '94)

Contact representations by triangles of a planar triangulation are in one-to-one correspondence with its Schnyder wood.

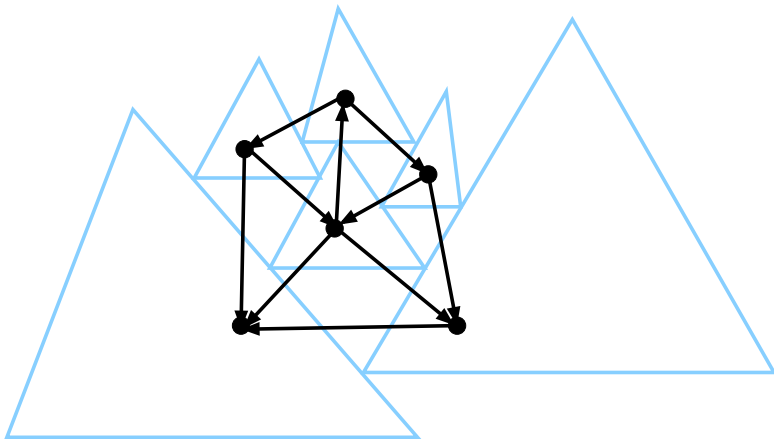

# Correspondence with Schnyder woods

Theorem (de Fraysseix, Ossona de Mendez, Rosenstiehl '94)

Contact representations by triangles of a planar triangulation are in one-to-one correspondence with its Schnyder wood.

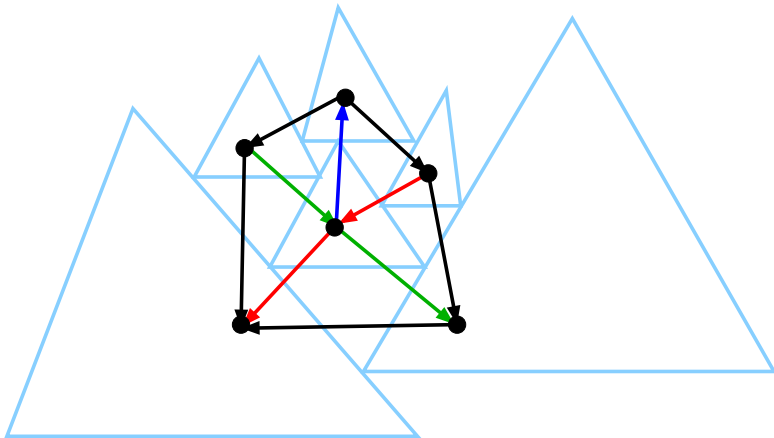

# Correspondence with Schnyder woods

Theorem (de Fraysseix, Ossona de Mendez, Rosenstiehl '94)

Contact representations by triangles of a planar triangulation are in one-to-one correspondence with its Schnyder wood.

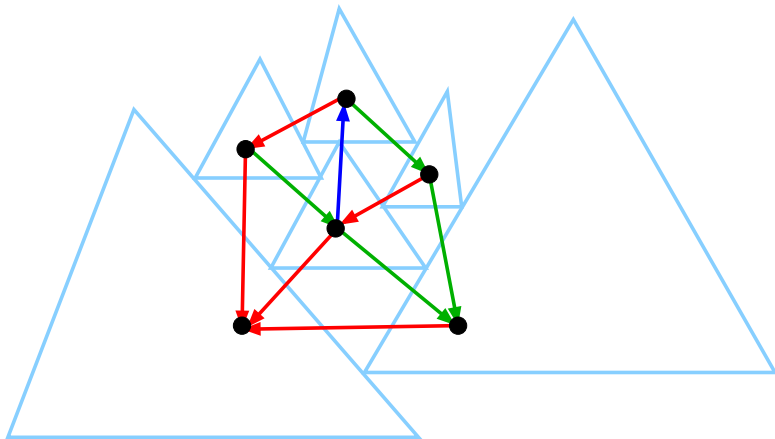



# Primal-Dual Representations

## Theorem (Koebe '36)

Every planar graph admits a contact representation by circles.

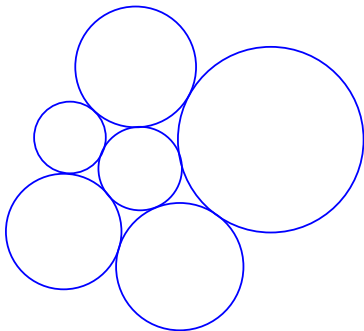

## Theorem (Koebe '36)

Every planar graph admits a contact representation by circles.

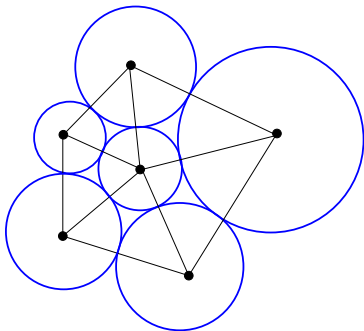

## Theorem (Andre'ev '70)

Every 3-connected planar map admits a primal-dual contact representation by circles.

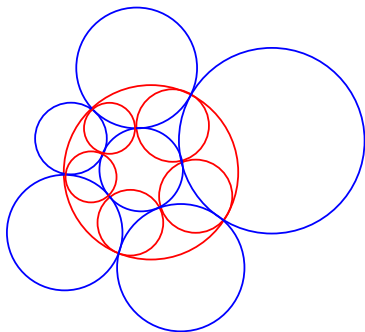

## Theorem (Andre'ev '70)

Every 3-connected planar map admits a primal-dual contact representation by circles.

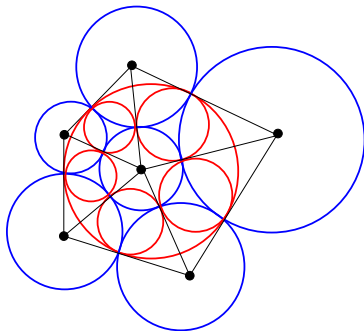

## Theorem (G., Lévêque, Pinlou '10)

Every 3-connected planar map admits a primal-dual contact representation by triangles.

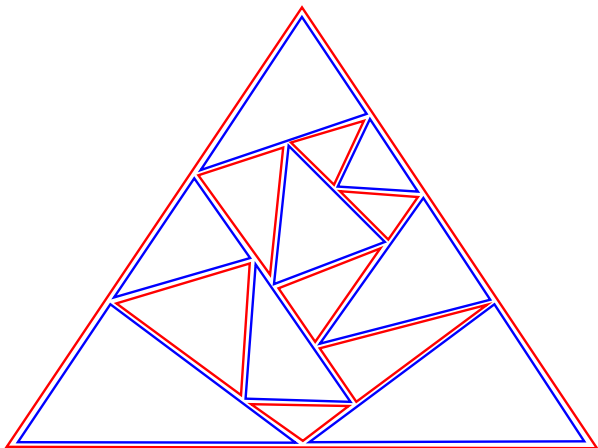

## Theorem (G., Lévêque, Pinlou '10)

Every 3-connected planar map admits a primal-dual contact representation by triangles.

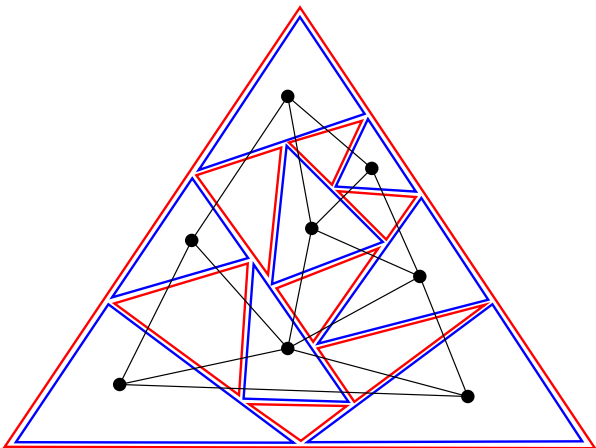

# Generalized Schnyder woods

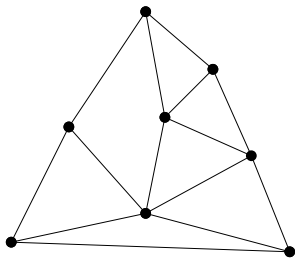



# Generalized Schnyder woods

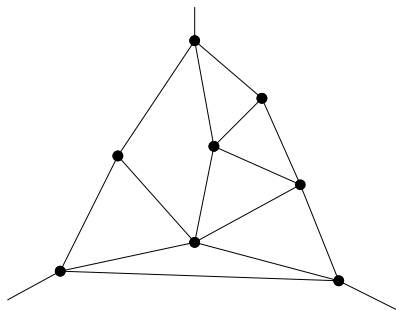

Add 3 edges on the outface

# Generalized Schnyder woods

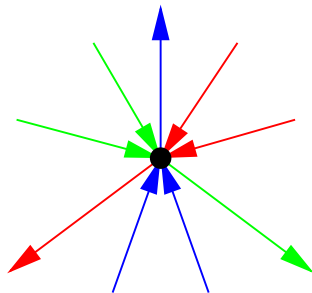

For inner vertices

# Generalized Schnyder woods

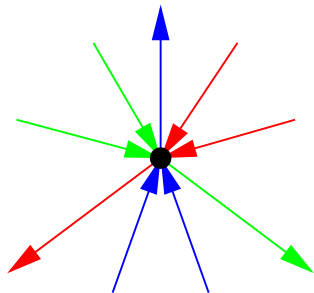

For EVERY vertex

# Generalized Schnyder woods

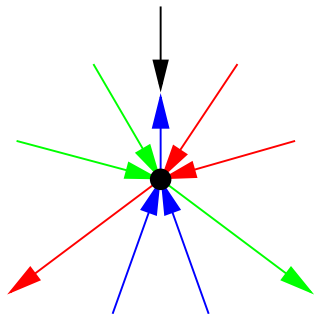

For EVERY vertex

Allow BI-ORIENTED edges

# Generalized Schnyder woods

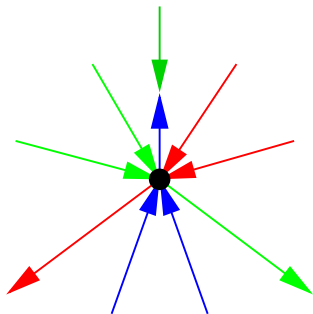

For EVERY vertex

Allow BI-ORIENTED edges

# Generalized Schnyder woods

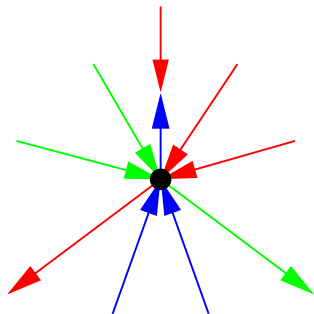

For EVERY vertex

Allow BI-ORIENTED edges

# Generalized Schnyder woods

## Theorem (Felsner '01)

Every 3-connected planar map admits a generalized Schnyder wood.

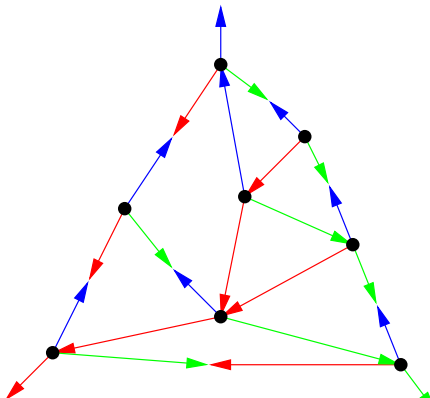

# Generalized Schnyder woods and Duality

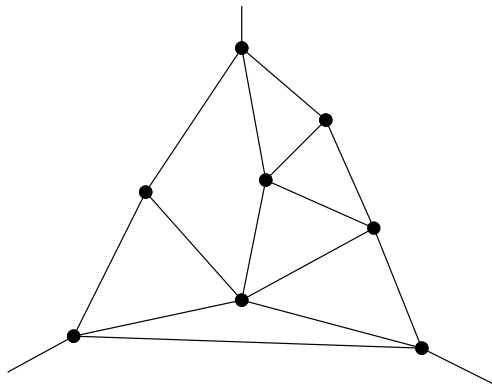



# Generalized Schnyder woods and Duality

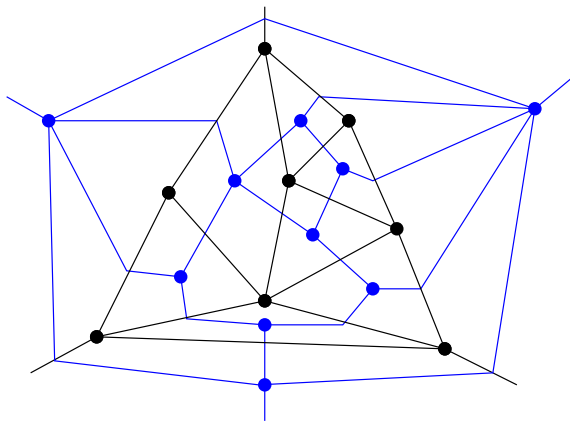

# Generalized Schnyder woods and Duality

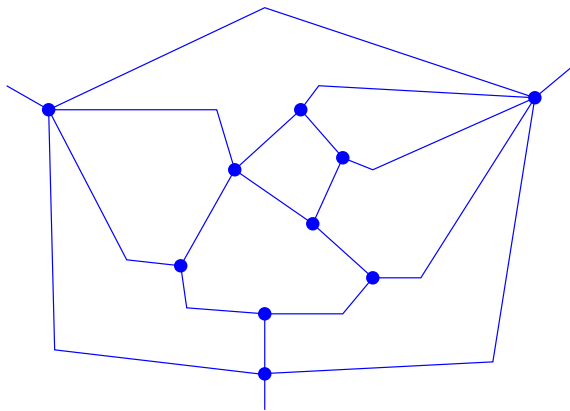

# Generalized Schnyder woods and Duality

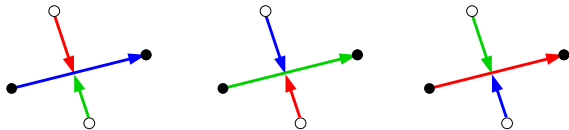

# Generalized Schnyder woods and Duality

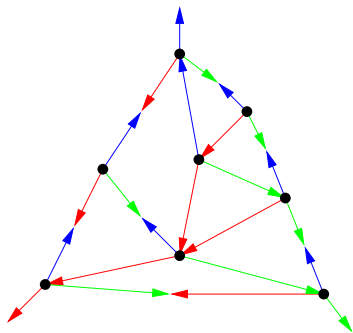
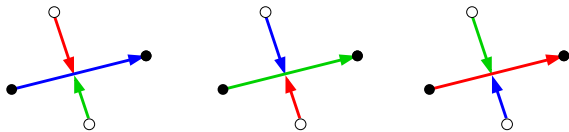

# Generalized Schnyder woods and Duality

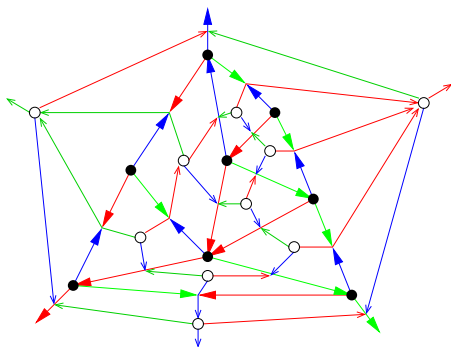
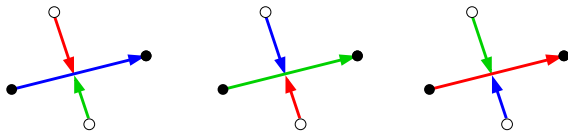

# Generalized Schnyder woods and Duality

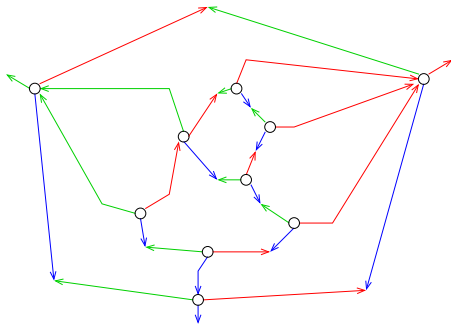
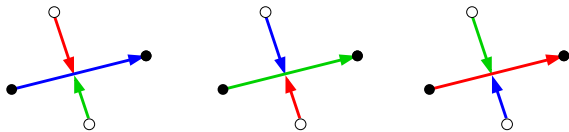

# The Construction on an Orthogonal Surfaces

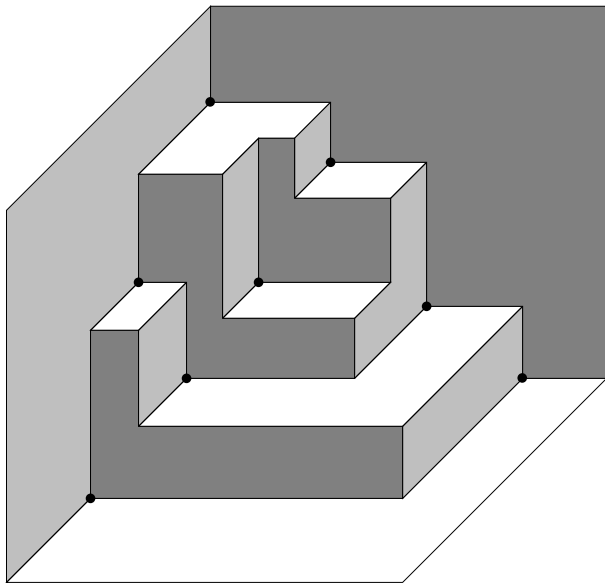

# The Construction on an Orthogonal Surfaces

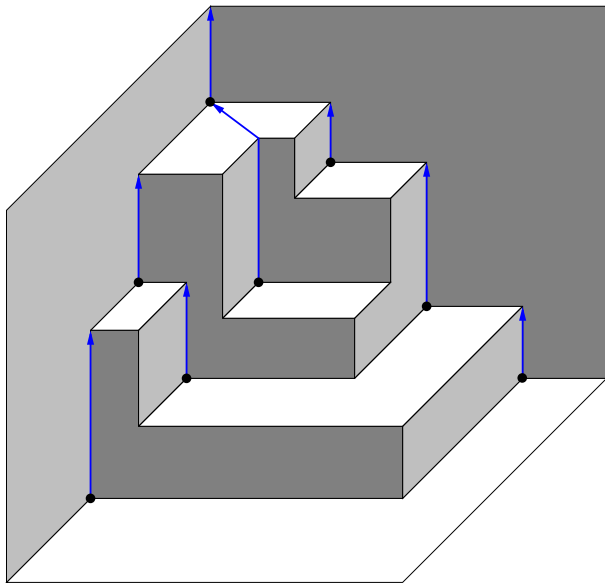



# The Construction on an Orthogonal Surfaces

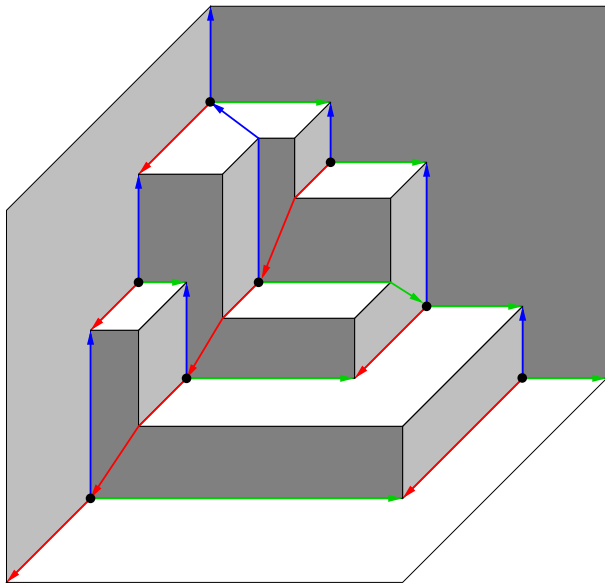

# The Construction on an Orthogonal Surfaces

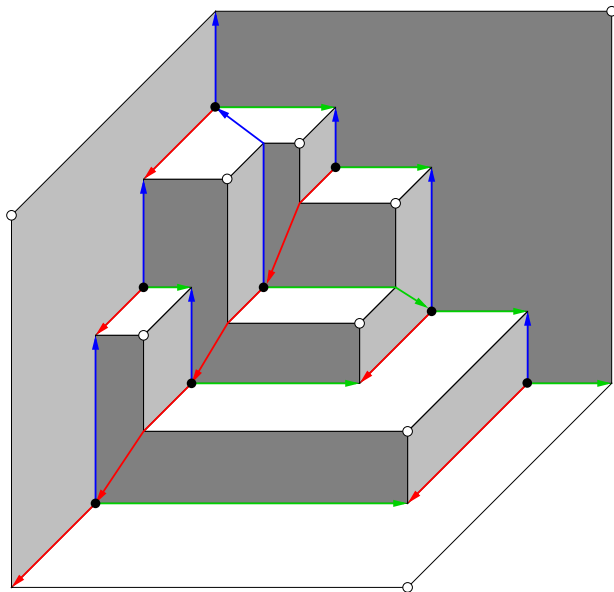

# The Construction on an Orthogonal Surfaces

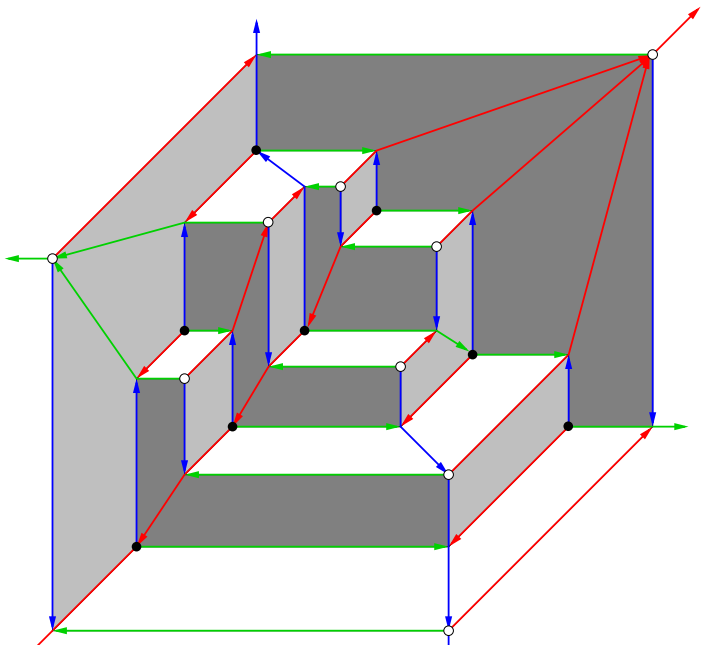

# The Construction on an Orthogonal Surfaces

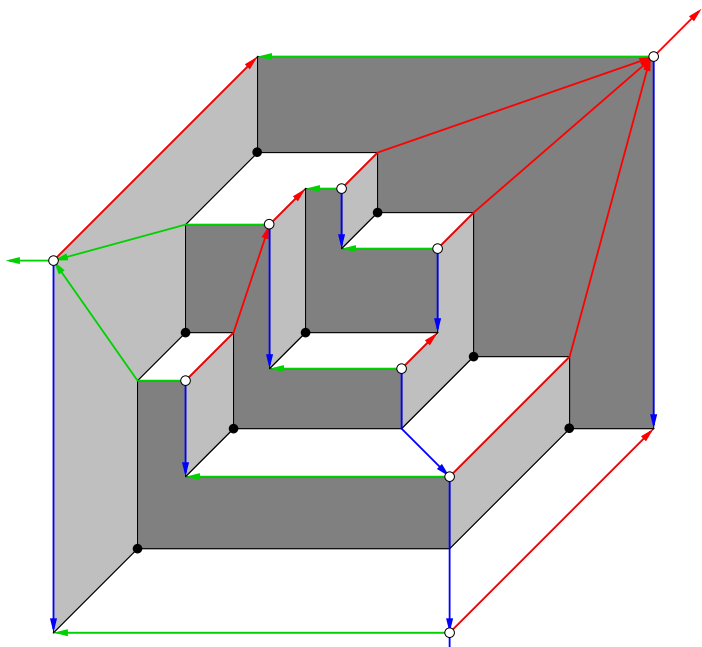

# The Construction on an Orthogonal Surfaces

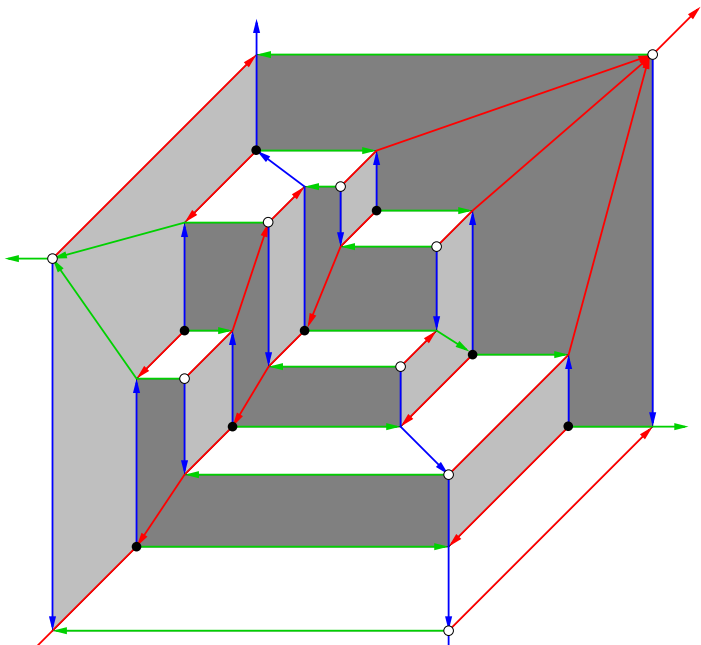

# The Construction on an Orthogonal Surfaces

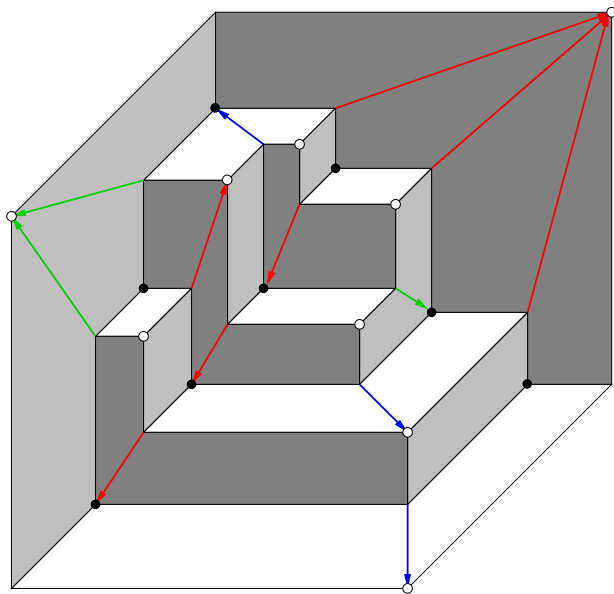

# The Construction on an Orthogonal Surfaces

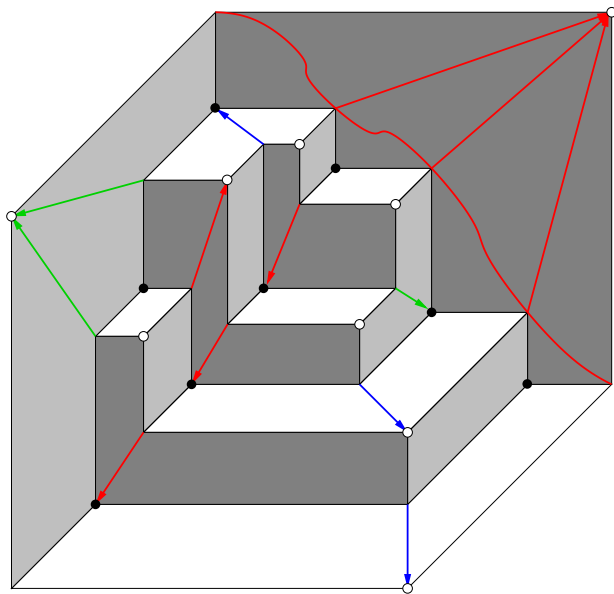

# The Construction on an Orthogonal Surfaces

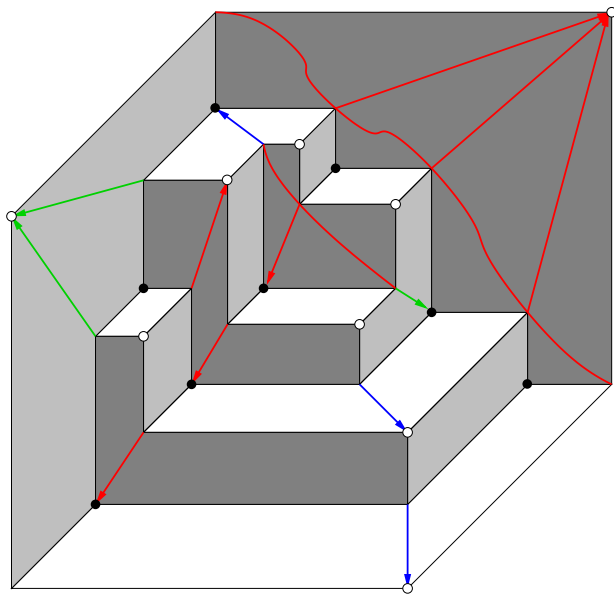



# The Construction on an Orthogonal Surfaces

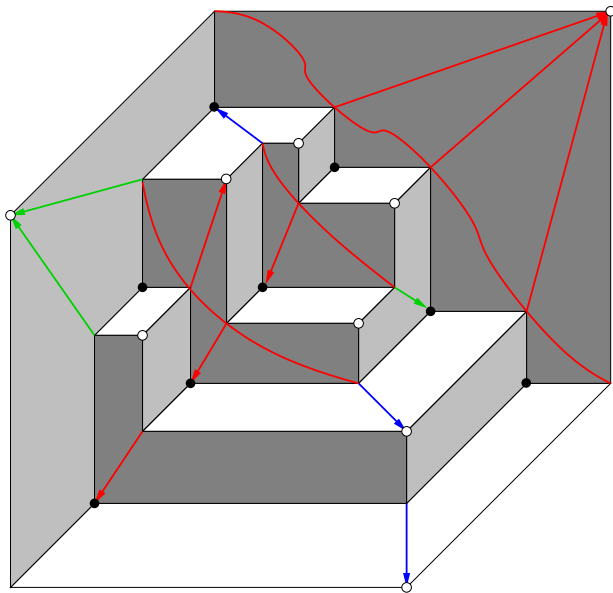

# The Construction on an Orthogonal Surfaces

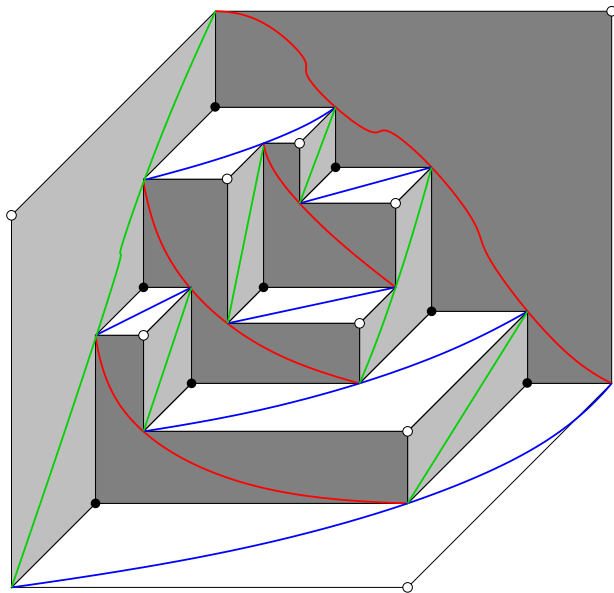

# The Construction on an Orthogonal Surfaces

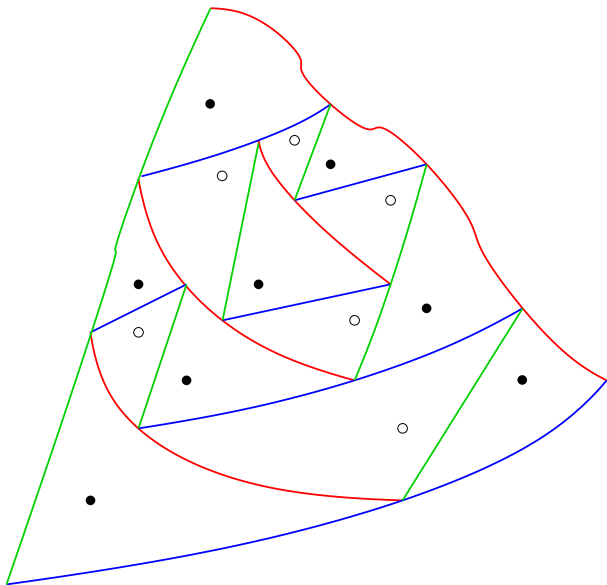

# The Construction on an Orthogonal Surfaces

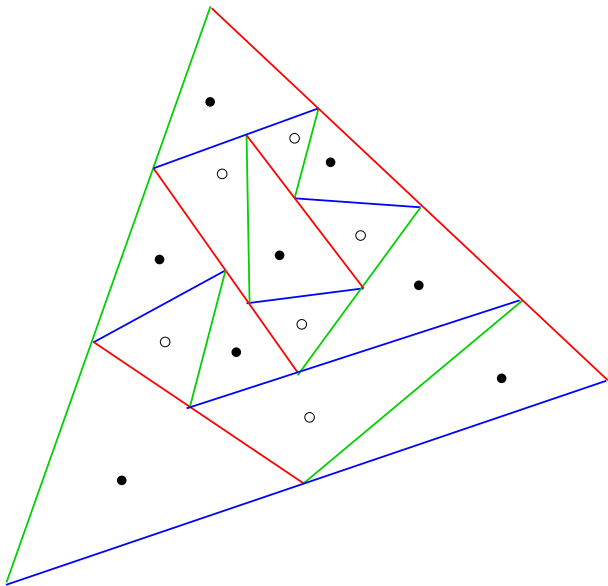

# The Construction on an Orthogonal Surfaces

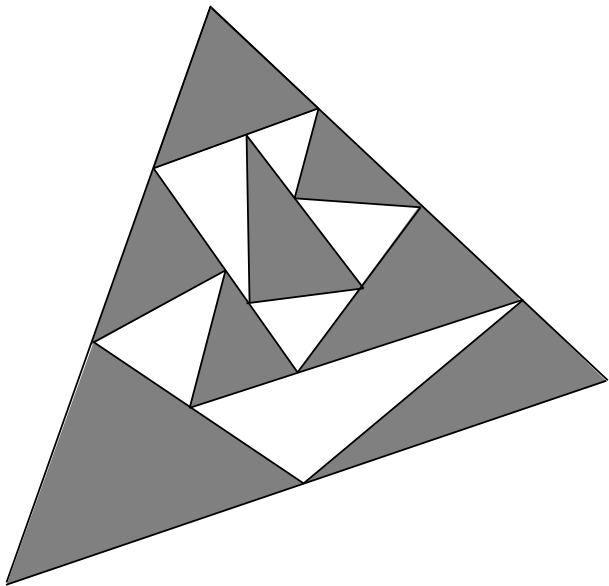

# How to Stretch

## Theorem (de Fraysseix, Ossona de Mendez '07)

A contact system of pseudo-segments (no loops or tangent arcs) is stretchable if and only if each subsystem of cardinality at least two has at least three extremal points.

# How to Stretch

## Theorem (de Fraysseix, Ossona de Mendez '07)

A contact system of pseudo-segments (no loops or tangent arcs) is stretchable if and only if each subsystem of cardinality at least two has at least three extremal points.

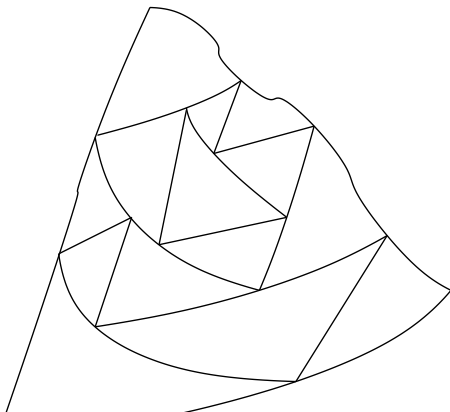

# How to Stretch

## Theorem (de Fraysseix, Ossona de Mendez '07)

A contact system of pseudo-segments (no loops or tangent arcs) is stretchable if and only if each subsystem of cardinality at least two has at least three extremal points.

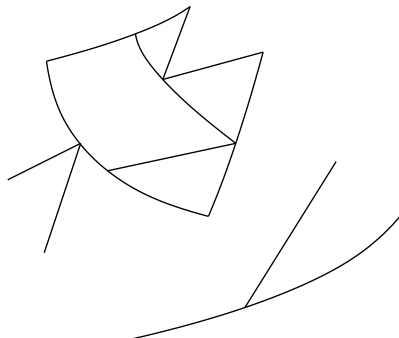



# How to Stretch

## Theorem (de Fraysseix, Ossona de Mendez '07)

A contact system of pseudo-segments (no loops or tangent arcs) is stretchable if and only if each subsystem of cardinality at least two has at least three extremal points.

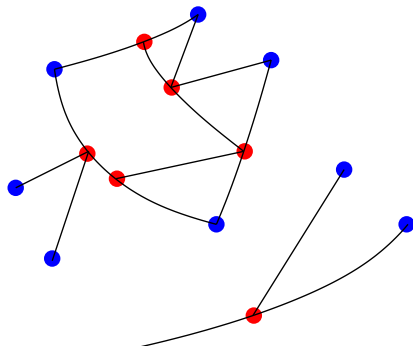

# How to Find Extremal Points ?

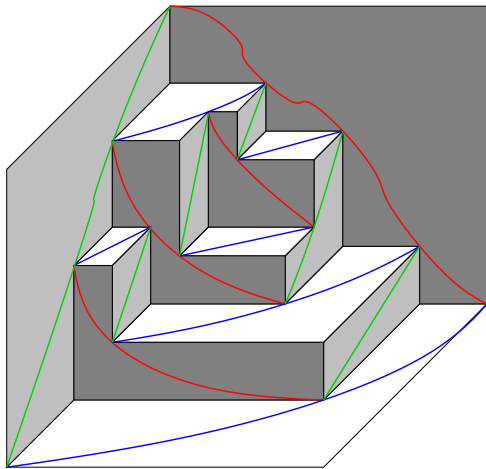

# How to Find Extremal Points ?

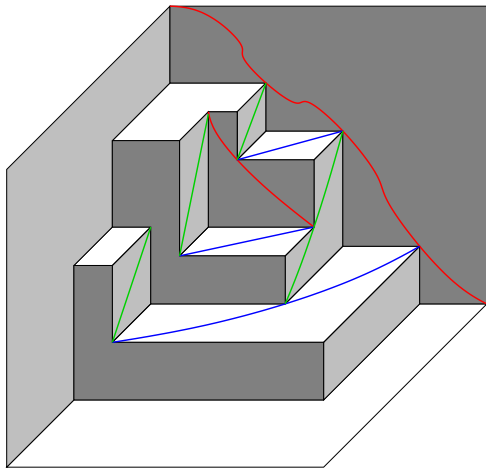

# How to Find Extremal Points ?

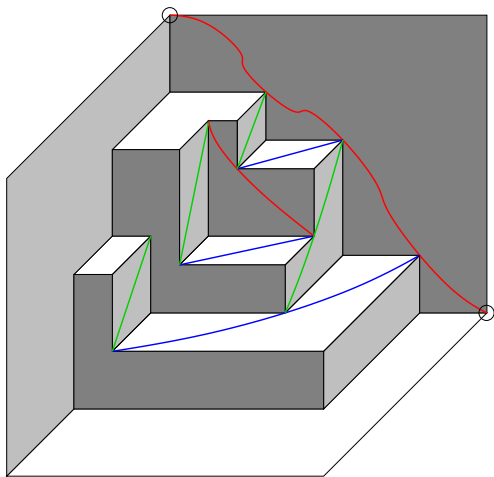

# How to Find Extremal Points ?

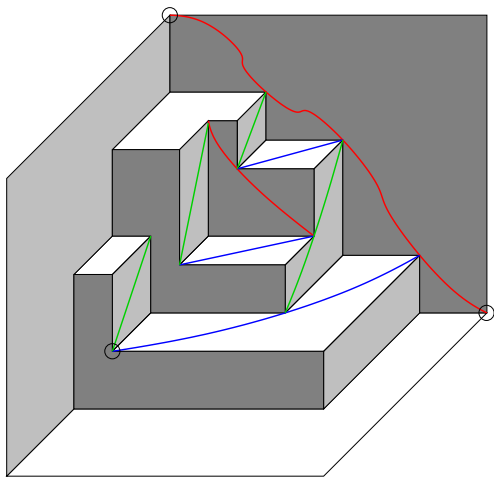

# Particular type of triangles ?

## ► Right triangles

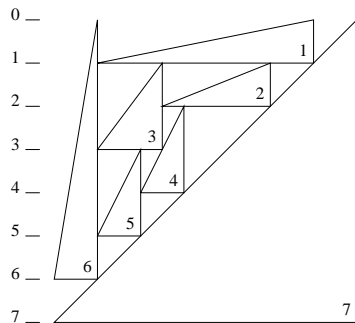

# Particular type of triangles ?

## ► Right triangles

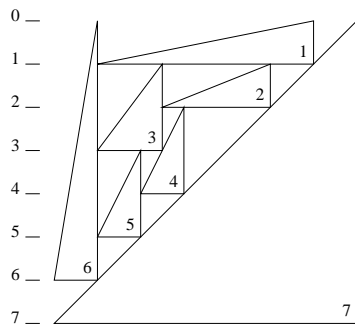

## Open Problem

Does every 3-connected planar map admits a primal-dual contact representation by right triangles?

## Homothetic Triangles



# Contact of Homothetic Triangles

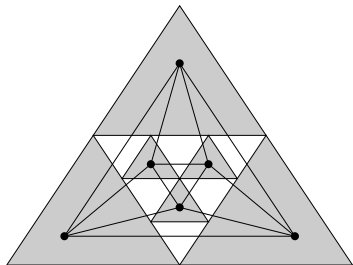

# Contact of Homothetic Triangles

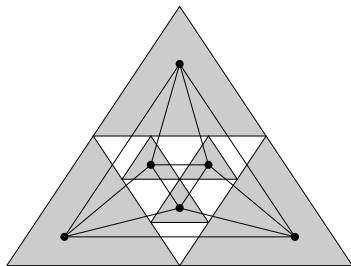

## Conjecture (Kratochvil '07)

Every 4-connected planar triangulation admits a contact representation by homothetic triangles.

# Contact of Homothetic Triangles

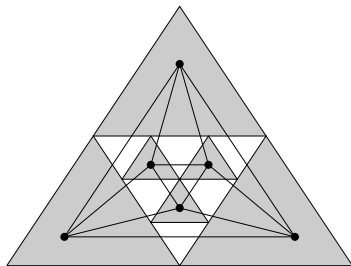

Theorem (by Schramm's Convex Packing Theorem)

Every 4-connected planar triangulation admits a contact representation by homothetic triangles.

# Schramm's Convex Packing Theorem

## Theorem (Schramm '90)

For any triangulation  $T$  and any convex and smooth bodies  $P_v$ , for  $v \in V(T)$ , there is a contact representation of  $T$

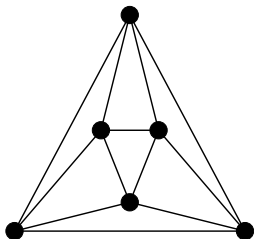

# Schramm's Convex Packing Theorem

## Theorem (Schramm '90)

For any triangulation  $T$  and any convex and smooth bodies  $P_v$ , for  $v \in V(T)$ , there is a contact representation of  $T$

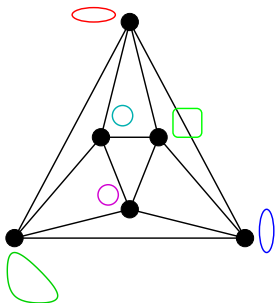

# Schramm's Convex Packing Theorem

## Theorem (Schramm '90)

For any triangulation  $T$  and any convex and smooth bodies  $P_v$ , for  $v \in V(T)$ , there is a contact representation of  $T$

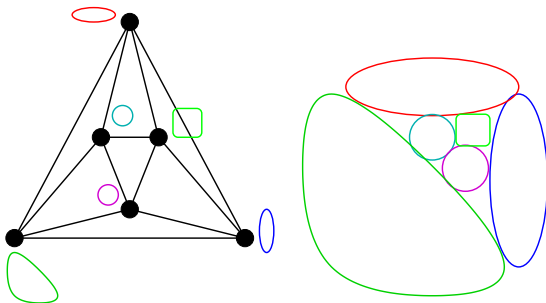

# Schramm's Convex Packing Theorem

## Theorem (Schramm '90)

For any triangulation  $T$  and any convex ~~and smooth~~ bodies  $P_v$ , for  $v \in V(T)$ , there is a contact representation of  $\mathbf{G} \supseteq T$ , with eventually degenerated triangles.

# Schramm's Convex Packing Theorem

## Theorem (Schramm '90)

For any triangulation  $T$  and any convex ~~and smooth~~ bodies  $P_v$ , for  $v \in V(T)$ , there is a contact representation of  $\mathbf{G} \supseteq T$ , with eventually degenerated triangles.

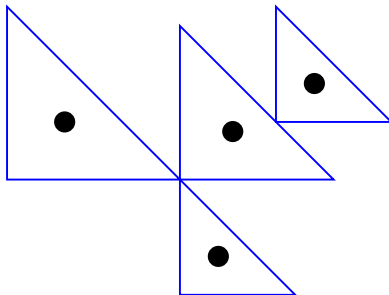



# Schramm's Convex Packing Theorem

## Theorem (Schramm '90)

For any triangulation  $T$  and any convex ~~and smooth~~ bodies  $P_v$ , for  $v \in V(T)$ , there is a contact representation of  $\mathbf{G} \supseteq T$ , with eventually degenerated triangles.

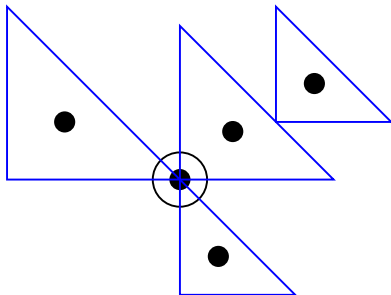

# Schramm's Convex Packing Theorem

## Theorem (Schramm '90)

For any triangulation  $T$  and any convex ~~and smooth~~ bodies  $P_v$ , for  $v \in V(T)$ , there is a contact representation of  $\mathbf{G} \supseteq T$ , with eventually degenerated triangles.

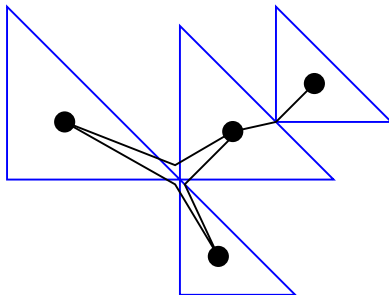

# Schramm's Convex Packing Theorem

## Theorem (Schramm '90)

For any triangulation  $T$  and any convex ~~and smooth~~ bodies  $P_v$ , for  $v \in V(T)$ , there is a contact representation of  $\mathbf{G} \supseteq T$ , with eventually degenerated triangles.

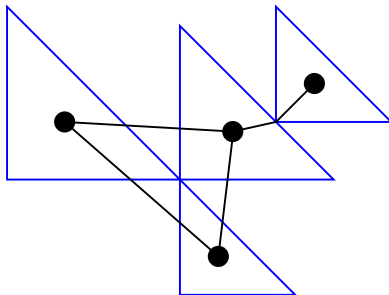

# Intersection of Homothetic Triangles

## Theorem

Every planar graph is the intersection graph of homothetic triangles (without 3 intersecting triangles).

# Intersection of Homothetic Triangles

## Theorem

Every planar graph is the intersection graph of homothetic triangles (without 3 intersecting triangles).

- ▶ Restriction to triangulations.

# Intersection of Homothetic Triangles

## Theorem

Every planar graph is the intersection graph of homothetic triangles (without 3 intersecting triangles).

- ▶ Restriction to triangulations.
- ▶ Work on the 4-connected components.

# Decomposition of Triangulations into 4CT

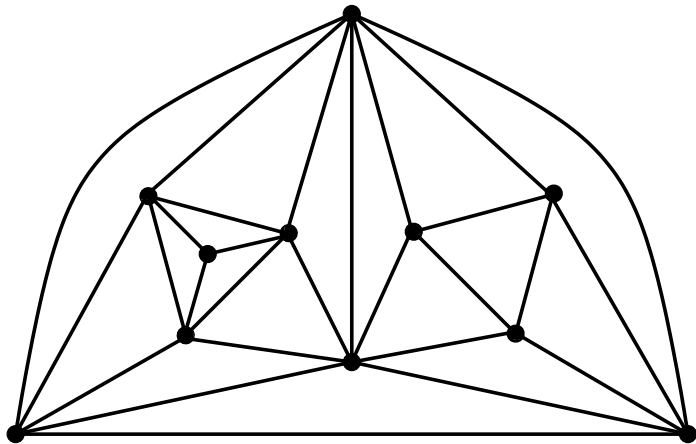

# Decomposition of Triangulations into 4CT

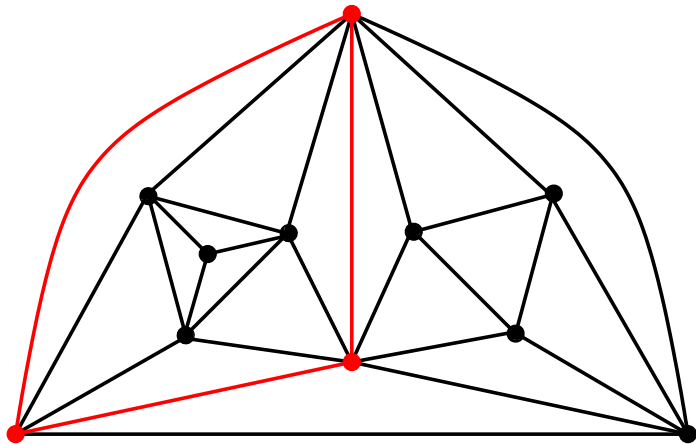



# Decomposition of Triangulations into 4CT

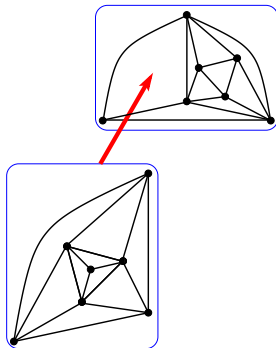

# Decomposition of Triangulations into 4CT

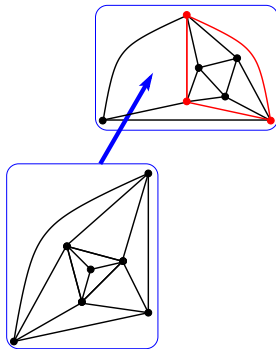

# Decomposition of Triangulations into 4CT

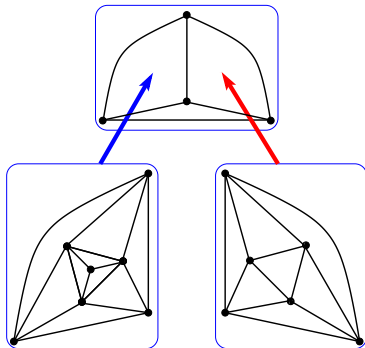

# Decomposition of Triangulations into 4CT

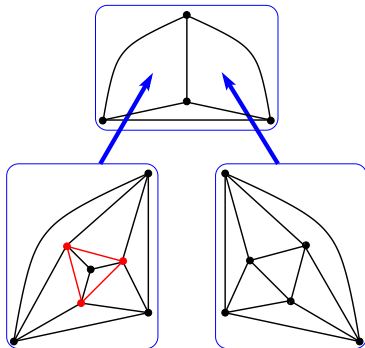

# Decomposition of Triangulations into 4CT

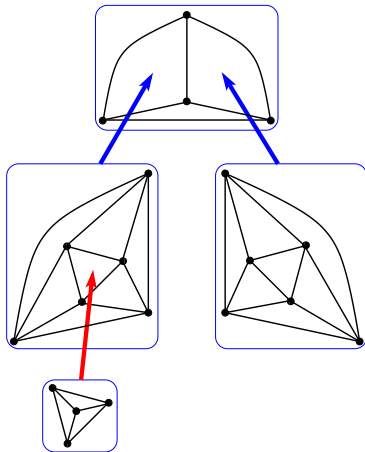

# Decomposition of Triangulations into 4CT

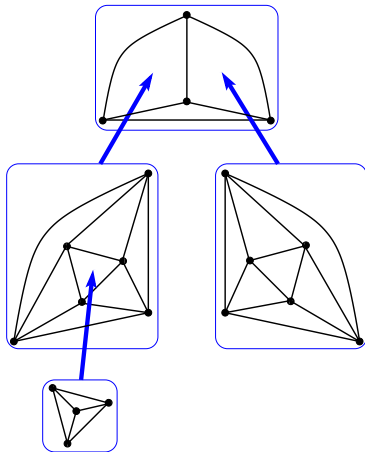

# 4-Connected Triangulations

## Theorem

For every 4-connected triangulation  $T$  and every  $\epsilon > 0$  there is an intersection system of homothetic triangles like that :

- ▶ No 3 intersecting triangles

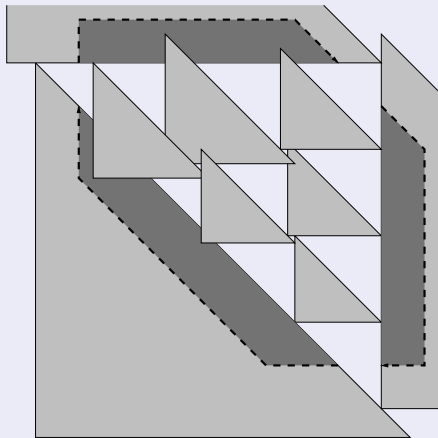

# Proof for 4-connected triangulations

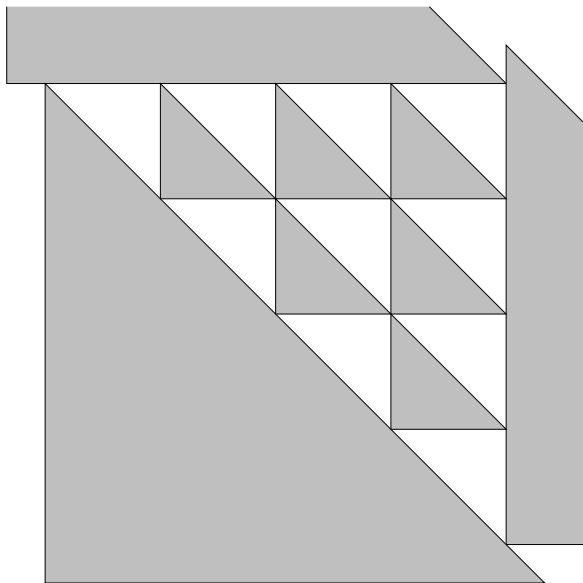



# Proof for 4-connected triangulations

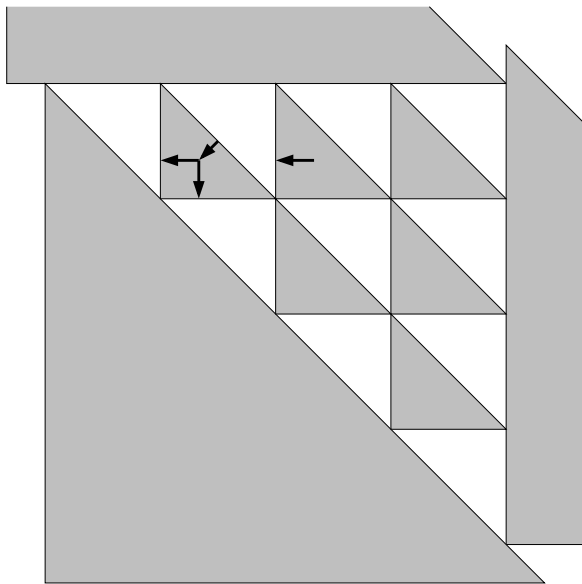

# Proof for 4-connected triangulations

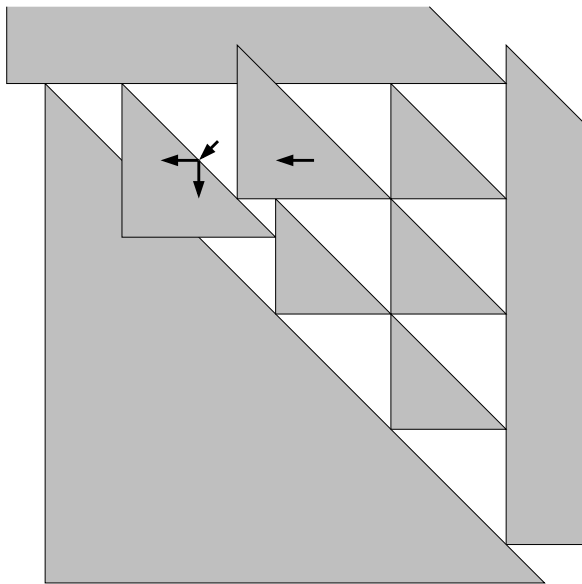

# Proof for 4-connected triangulations

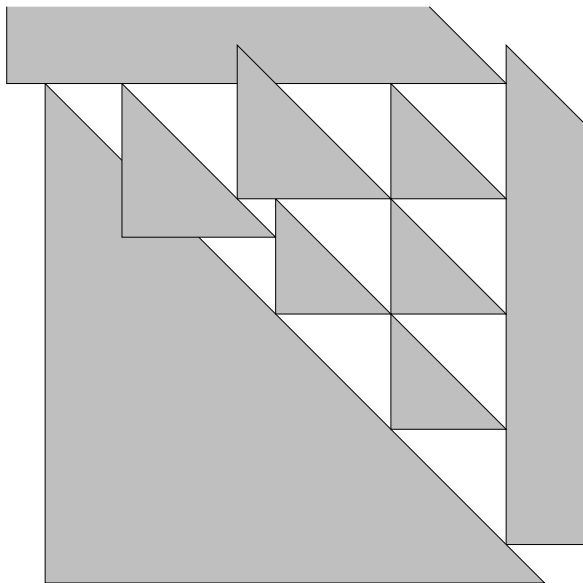

# Proof for 4-connected triangulations

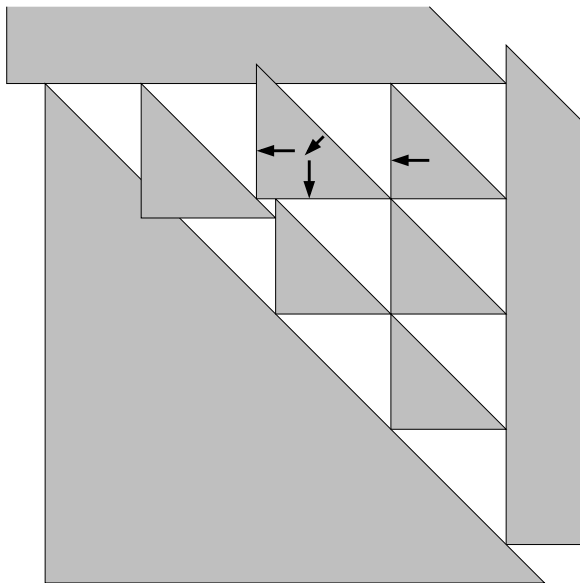

# Proof for 4-connected triangulations

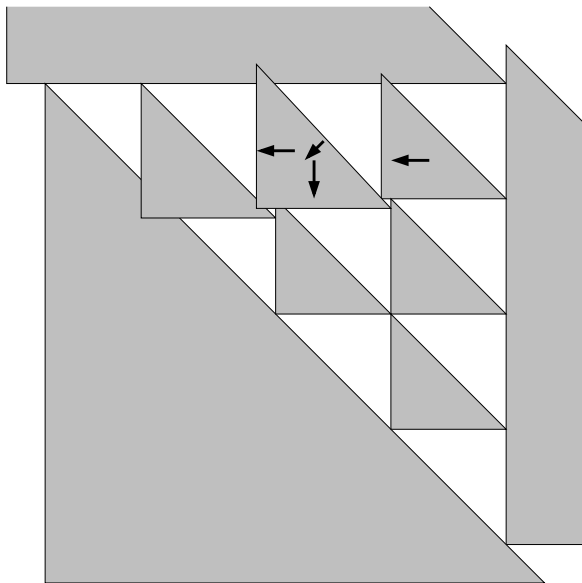

# Proof for 4-connected triangulations

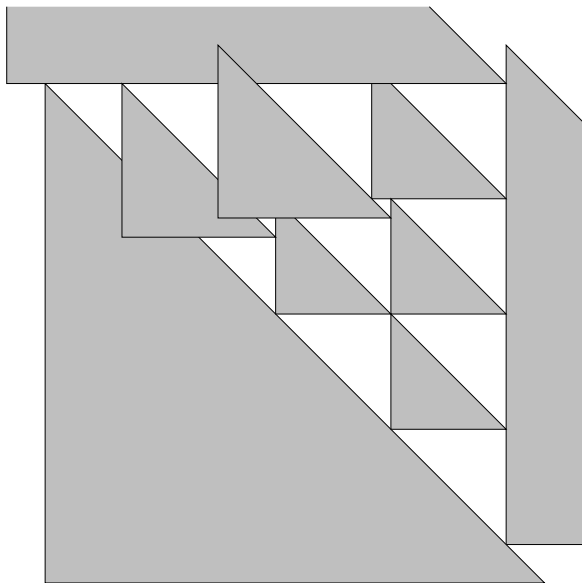

# Proof for 4-connected triangulations

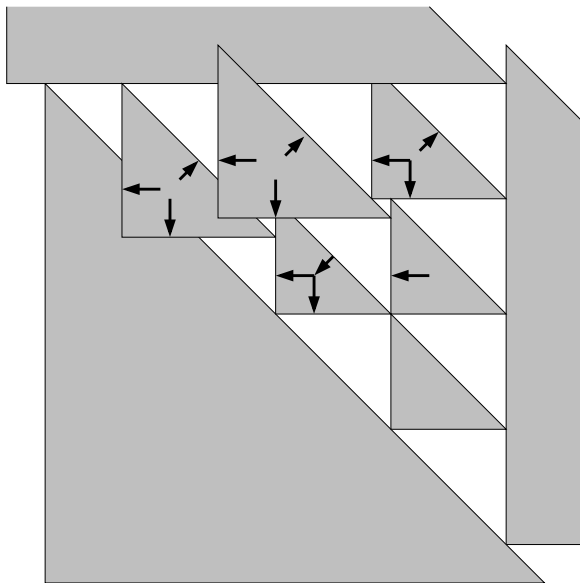

# Proof for 4-connected triangulations

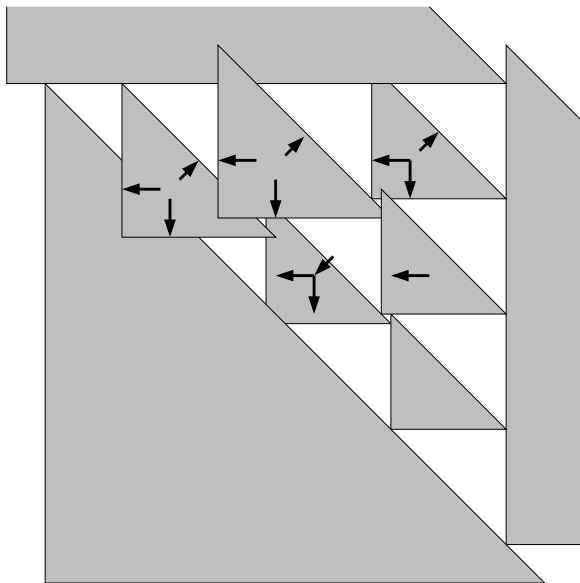



# Proof for 4-connected triangulations

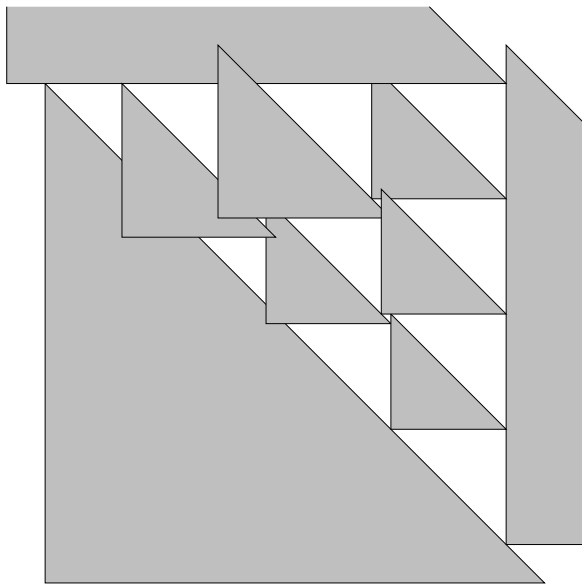

Thank you !